



HAL
open science

String Stable H^∞ LPV Cooperative Adaptive Cruise Control with a Variable Time Headway

Khaled Laib, Olivier Sename, Luc Dugard

► **To cite this version:**

Khaled Laib, Olivier Sename, Luc Dugard. String Stable H^∞ LPV Cooperative Adaptive Cruise Control with a Variable Time Headway. IFAC WC 2020 - 21st IFAC World Congress, Jul 2020, Berlin (virtual), Germany. 10.1016/j.ifacol.2020.12.2039 . hal-02940698

HAL Id: hal-02940698

<https://hal.univ-grenoble-alpes.fr/hal-02940698>

Submitted on 16 Sep 2020

HAL is a multi-disciplinary open access archive for the deposit and dissemination of scientific research documents, whether they are published or not. The documents may come from teaching and research institutions in France or abroad, or from public or private research centers.

L'archive ouverte pluridisciplinaire **HAL**, est destinée au dépôt et à la diffusion de documents scientifiques de niveau recherche, publiés ou non, émanant des établissements d'enseignement et de recherche français ou étrangers, des laboratoires publics ou privés.

String Stable H_∞ LPV Cooperative Adaptive Cruise Control with a Variable Time Headway

Khaled Laib* Olivier Sename** Luc Dugard**

* *Department of Engineering, University of Cambridge
Trumpington Street Cambridge CB2 1PZ, UK
(e-mail: k1507@cam.ac.uk).*

** *Univ. Grenoble Alpes, CNRS, Grenoble INP, GIPSA-lab, 38000
Grenoble, France (e-mail: olivier.sename@grenoble-inp.fr)*¹

Abstract: Cooperative Adaptive Cruise Control with a variable time headway is considered in this paper. The two main objectives are the convergence of the spacing errors towards zero and the attenuation of any disturbance propagating along the platoon. To ensure those objectives for any variable time headway, the H_∞ - Linear Parameter Varying approach is used. The efficiency of the designed controller is illustrated through frequency domain analysis and time domain simulations.

Keywords: Cooperative Adaptive Cruise Control, Linear Parameter Varying, H_∞ control.

1. INTRODUCTION

Vehicle platooning in closely spaced groups has become a solution to traffic congestion due to its benefits, *e.g.* enhancing road safety, improving highway utility and increasing fuel economy, see Hedrick et al. (1994). To ensure the safe operation of such vehicle platoons, the vehicle longitudinal dynamics have been equipped with control systems in order to automatically accelerate and decelerate and keep a desired inter-vehicle distance.

Adaptive Cruise Control (ACC) is a vehicle-following control system that automatically accelerates and decelerates a vehicle to keep the desired distance, see Ioannou and Chien (1993); Vahidi and Eskandarian (2003). In available commercial ACC systems, for comfort and safety reasons, the desired inter-vehicle distances are usually large which limits the traffic throughput. To increase the traffic throughput and to form long vehicle platoons, small inter-vehicle distances are required. Nevertheless, a risk that may occur is the unstable string behaviour where any disturbance is amplified when propagating along the platoon.

Cooperative Adaptive Cruise Control (CACC) was introduced as an extension of ACC by enabling wireless inter-vehicle communications, see Rajamani and Zhu (2002); Shladover (2005), allowing to achieve smaller inter-vehicle distances while maintaining string stability.

Therefore, the two fundamental aspects of high interest in ACC/CACC are: the spacing policy (static or dynamic) and the *string stability* (see Swaroop and Hedrick (1996)). Since the most common policy is constant spacing, time headway based policy have gained interest due to the dependence on the vehicle velocity (allowing to reduce the inter-vehicle space), see Flores et al. (2017). On the other hand, string stability is to be proved considering

velocity variations of the lead vehicle or initial condition disturbances of the platoon vehicles, which can be done in an H_∞ framework through a frequency domain criterion to guarantee the attenuation of disturbances along the platoon as in Seiler et al. (2004); Ploeg et al. (2014); Kayacan (2017).

Nevertheless, as those controllers were designed to operate with a constant time headway they cannot be adapted to variable time headway (Flores et al. (2017)) without redesigning the controller. Some nonlinear CACC with variable time headway could be found in the literature, see *e.g.* Yanakiev and Kanellakopoulos (1998). However, string stability cannot be guaranteed for small time headway values. Furthermore, the nonlinear controllers are difficult to analyse using linear systems tools such as frequency response and Bode plots can no longer be used in the analysis.

In this paper, CACC is considered with a variable time headway which can cope with several policies (incl. Constant Safety Factor) as the one proposed by (Flores et al., 2017) with a polynomial dependence on the velocity. The interest of such a policy is to achieve safe high traffic density in urban and highway scenarios. The CACC design is tackle here for the first time in the Linear Parameter Varying (LPV) framework allowing to handle variable time headway and to ensure *a priori* string stability.

The paper is organized as follows. Section 2 presents the problem formulation and section 3 gives the LPV model and control design methodology. Section 4 provides a frequency domain analysis of the control scheme and time domain simulations. Section 5 concludes this study.

2. PROBLEM FORMULATION

Consider the vehicle platoon consisting of N vehicles as illustrated in Fig. 1. Each vehicle is denoted \mathcal{V}_i with $i \in \mathcal{N}$

¹ Institute of Engineering Univ. Grenoble Alpes

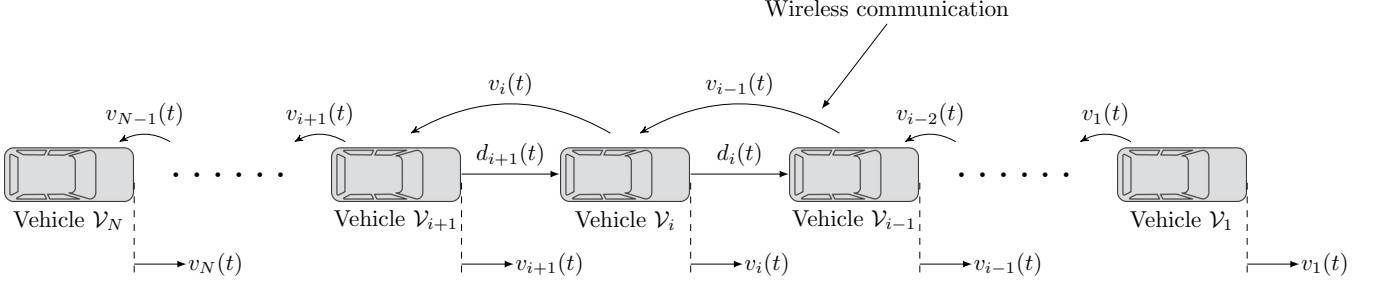

Fig. 1. Schematic of N vehicle platoon

where \mathcal{N} denotes the set $\{1, 2, \dots, N\}$. Each vehicle \mathcal{V}_i in the platoon receives the velocity of its predecessor vehicle \mathcal{V}_{i-1} , with $i \in \mathcal{N} \setminus \{1\}$, via wireless communication.

In this section, a generic model of a homogeneous platoon consisting of N vehicles is presented followed by the notion of string stability and the influence of time headway in order to formulate the problem considered in this paper.

2.1 Platoon dynamics

The main objective of each vehicle \mathcal{V}_i , with $i \in \mathcal{N}$, in the platoon is to maintain a desired distance $d_{r,i}$, with respect to its predecessor vehicle \mathcal{V}_{i-1} . The variable time headway based policy is given as follows

$$d_{r,i}(t) = d_{0,i} + h(v_i)v_i(t) \quad (1)$$

where $d_{0,i}$ is the standstill distance of vehicle \mathcal{V}_i , $h(v_i)$ is the time headway² and $v_i(t)$ is the velocity of vehicle \mathcal{V}_i . It is worth noting that this definition allows to consider the variable non-linear time gap policies presented in (Flores et al., 2017).

The actual relative distance between vehicle \mathcal{V}_i and its preceding vehicle \mathcal{V}_{i-1} is denoted $d_i(t)$ and is given by

$$d_i(t) = p_{i-1}(t) - p_i(t) - L_{i-1,i} \quad i \in \mathcal{N} \setminus \{1\}. \quad (2)$$

where $p_{i-1}(t)$ and $p_i(t)$ denote the position of vehicle \mathcal{V}_{i-1} and the position of vehicle \mathcal{V}_i respectively. $L_{i,i-1}$ denotes the summation of two lengths: the first is from the gravity center of vehicle \mathcal{V}_{i-1} to its rear bumper and the second is from the gravity center of vehicle \mathcal{V}_i to its front bumper.

For each $i \in \mathcal{N} \setminus \{1\}$, the spacing error $e_i(t)$ is defined as the difference between the actual distance $d_i(t)$ and the desired distance $d_{r,i}(t)$, that is

$$e_i = (p_{i-1} - p_i - L_{i-1,i}) - (d_{0,i} + h(v_i)v_i). \quad (3)$$

The first vehicle in the platoon \mathcal{V}_1 is considered to follow a *virtual reference vehicle* (corresponding to index $i = 0$). The error e_1 could be thus defined as the spacing error between the first vehicle and the virtual reference vehicle whose position and velocity are denoted $p_0(t)$ and $v_0(t)$ respectively.

Remark 1. Please note that the virtual velocity $v_0(t)$ is generated by the platoon operator according to a predefined operating scenario.

² h represents the time that vehicle \mathcal{V}_i will take to arrive at the same position as its predecessor \mathcal{V}_{i-1} when the standstill distance $d_{0,i}$ is equal to zero.

The vehicle dynamics are presented by the simple model

$$\dot{v}_i(t) = F_i(t)/M_i \quad (4)$$

where $F_i(t)$ is the resulting traction forces and M_i is the mass of vehicle \mathcal{V}_i . Please note that $F_i(t)$ is the considered control input of vehicle \mathcal{V}_i . Note that, in the simulation results, the vehicle are assumed homogeneous.

Moreover, following the usual variable spacing policies, it is here assumed that $h(v_i)$ is much smaller than 1. Therefore, the considered model for each vehicle \mathcal{V}_i , with $i \in \mathcal{N}$, is given by

$$\begin{cases} \dot{e}_i(t) = v_{i-1}(t) - v_i(t) - h(v_i)F_i(t)/M_i \\ \dot{v}_i(t) = F_i(t)/M_i \end{cases} \quad \forall i \in \mathcal{N} \quad (5)$$

It is worth noting that the time headway $h(v_i)$ is also assumed to vary within a fixed range in accordance with the chosen time gap policy, that is

$$h(v_i) \in [\underline{h}, \bar{h}], \quad \forall v_i$$

In what follows, $h(v_i)$ will be denoted h for simplicity when there is no confusion.

2.2 String stability

String stability can be characterized as the attenuation of the disturbance effects along the platoon. In the CACC considered in this paper, the different velocities $v_i(t)$ are the signals exchanged between vehicles \mathcal{V}_i via wireless communication. Therefore, it is those signals that will be used in the string stability criterion to ensure that any velocity disturbance of an individual vehicle in a string do not amplify when they propagate upstream.

The following string stability criterion is adapted from Seiler et al. (2004)

$$\|v_i(t)\|_{\mathcal{L}_2} \leq \|v_{i-1}(t)\|_{\mathcal{L}_2} \quad \forall i \in \mathcal{N} \quad (6)$$

where $\|v_i(t)\|_{\mathcal{L}_2}$ denotes the \mathcal{L}_2 norm of the signal $v_i(t)$.

Please note that for \mathcal{V}_1 , the string stability is with respect to $v_0(t)$ which is not required as $v_0(t)$ is just a virtual signal and does not correspond to any vehicle. The term $\forall i \in \mathcal{N}$ in (6) could be then replaced by $i \in \mathcal{N} \setminus \{1\}$. However, this distinction is omitted in order to ease the notation and not to make distinction between vehicle \mathcal{V}_1 and other vehicles in the control design.

2.3 Problem Statement

Consider a vehicle platoon consisting of N vehicles whose dynamics are given by (5) with $h \in [\underline{h}, \bar{h}]$, the CACC problem consists in finding a controller K_i , whose output

is $F_i(t)$, for each vehicle \mathcal{V}_i , with $i \in \mathcal{N}$, which satisfy the following control requirements

- *inter-vehicle distance tracking error convergence*: For each vehicle \mathcal{V}_i , with $i \in \mathcal{N}$, and if $v_{i-1}(t) = c$ with c some velocity constant, the controller K_i has to ensure

$$\lim_{t \rightarrow \infty} e_i(t) = 0 \quad \forall i \in \mathcal{N}.$$

- *Platoon string stability*: For each vehicle \mathcal{V}_i , with $i \in \mathcal{N}$, the controller K_i has to ensure

$$\|v_i(t)\|_{\mathcal{L}_2} \leq \|v_{i-1}(t)\|_{\mathcal{L}_2} \quad \forall i \in \mathcal{N}$$

3. CONTROLLER DESIGN

As seen before, since it assumed that the time headways h vary within a range $[\underline{h}, \bar{h}]$, each vehicle \mathcal{V}_i dynamical behavior depends on the varying parameter h . Therefore, the design of each controller K_i will be treated in Linear Parameter Varying (LPV) control framework. More precisely, the polytopic H_∞ approach for LPV systems will be adopted here to achieve the different closed loop control objectives.

In this section, a brief background on LPV systems and the polytopic H_∞ approach for LPV systems is presented. Furthermore, an augmented suitable LPV control model for each vehicle \mathcal{V}_i is derived. Some additional components (weighting functions) are added to the obtained model to capture the different CACC control objectives considered in this paper.

3.1 Brief background on LPV control design

The material presented in this subsection is from Pousot-Vassal (2009) and more details can also be found in Apkarian et al. (1995).

Consider the convex set Θ of varying parameters

$$\Theta = \left\{ \theta \left| \begin{array}{l} \theta = (\theta_1 \dots \theta_{n_\theta})^T \in \mathbf{R}^{n_\theta} \\ \text{with } \theta_m \in [\underline{\theta}_m, \bar{\theta}_m] \quad \forall m \in \{1, \dots, n_\theta\} \end{array} \right. \right\} \quad (7)$$

A dynamical LPV system can be described as follows

$$P(\theta) : \begin{pmatrix} \dot{\xi}(t) \\ z(t) \\ y(t) \end{pmatrix} = \begin{pmatrix} A(\theta) & B_1(\theta) & B_2(\theta) \\ C_1(\theta) & D_{11}(\theta) & D_{12}(\theta) \\ C_2(\theta) & D_{21}(\theta) & 0 \end{pmatrix} \begin{pmatrix} \xi(t) \\ w(t) \\ u(t) \end{pmatrix} \quad (8)$$

where $\xi(t)$, $w(t)$ and $u(t)$ are the state vector, the exogenous and the control inputs, respectively; $z(t)$ and $y(t)$ hold for the controlled outputs and the measured outputs, respectively. $\theta \in \Theta$ is the set of varying parameters that describe a set of systems. $A(\theta) \in \mathbf{R}^{n_\xi \times n_\xi}$, $B_1(\theta) \in \mathbf{R}^{n_\xi \times n_w}$, $B_2(\theta) \in \mathbf{R}^{n_\xi \times n_u}$, $C_1(\theta) \in \mathbf{R}^{n_z \times n_\xi}$, $D_{11}(\theta) \in \mathbf{R}^{n_z \times n_w}$, $D_{21}(\theta) \in \mathbf{R}^{n_z \times n_u}$, $C_2(\theta) \in \mathbf{R}^{n_y \times n_\xi}$, and $D_{21}(\theta) \in \mathbf{R}^{n_y \times n_w}$.

Please note that the dynamical system representation includes the performance weighting function which are usually used in the H_∞ approach to achieve some closed-loop requirements. Therefore, the vector $\xi(t)$ contains the state vector of the system in addition to the state vector of the weighting functions (as seen later).

A dynamical LPV controller is defined by

$$K(\theta) : \begin{pmatrix} \dot{x}_K(t) \\ u(t) \end{pmatrix} = \begin{pmatrix} A_K(\theta) & B_K(\theta) \\ C_K(\theta) & D_K(\theta) \end{pmatrix} \begin{pmatrix} x_K(t) \\ y(t) \end{pmatrix} \quad (9)$$

where $x_K(t)$, $y(t)$ and $u(t)$ are the state, the control input and the control output, respectively, of the controller associated to system (8). $A_K(\theta) \in \mathbf{R}^{n_\xi \times n_\xi}$, $B_K(\theta) \in \mathbf{R}^{n_\xi \times n_y}$, $C_K(\theta) \in \mathbf{R}^{n_u \times n_\xi}$, and $D_K(\theta) \in \mathbf{R}^{n_u \times n_y}$.

The H_∞ control problem for the LPV system $P(\theta)$ consists in finding a LPV controller $K(\theta)$ such that the closed loop system is quadratically stable and that, for a given positive real γ , the \mathcal{L}_2 -induced norm of the operator mapping w into z is bounded by γ for all possible trajectories of θ .

Assuming that

- (1) the different varying parameters θ_m of (7) are independent and the different matrices of the LPV plant state space realisation of (8) are affine with respect to the parameter vector θ .
- (2) the input and the output matrices do not depend on the varying parameters θ that is

$$B_2(\theta) = B_2, D_{12}(\theta) = D_{12}, C_2(\theta) = C_2, D_{21}(\theta) = D_{21}.$$

Therefore, using a single Lyapunov function (quadratic stability) and the global attenuation level γ , a LPV controller is obtained by solving an off-line Linear Matrix Inequalities (LMI) problem evaluated at each vertex of the polytope formed by the extremum values of the parameters.

The state space matrices of the LPV controller (9) are then computed on-line as a convex combination of the vertices controllers

$$\begin{pmatrix} A_K(\theta) & B_K(\theta) \\ C_K(\theta) & D_K(\theta) \end{pmatrix} = \mathbf{Co} \left\{ \begin{pmatrix} A_j & B_j \\ C_j & D_j \end{pmatrix} \right\}$$

where \mathbf{Co} denotes the convex combination and $j = 1, \dots, 2^{n_\theta}$ where n_θ represents the number of vertices forming the polytope. The matrices $\begin{pmatrix} A_j & B_j \\ C_j & D_j \end{pmatrix}$ are the controller state space matrices corresponding to the j^{th} vertex.

3.2 Vehicle \mathcal{V}_i LPV model

In order to solve the CACC problem with variable time headway presented in Section 2 within LPV framework, a first step is to elaborate a suitable control model.

As it was mentioned earlier, it is assumed that for each vehicle \mathcal{V}_i the measures of spacing error $e_i(t)$ and the velocity $v_i(t)$ are available (measured or estimated); and that the predecessor velocity $v_{i-1}(t)$ is transmitted through wireless communication to vehicle \mathcal{V}_i . Therefore, a control oriented LPV model for (5) can be given with the following state space representation

$$\begin{cases} \dot{x}_i(t) = Ax_i(t) + B^{w_i} w_i(t) + B^{F_i}(h) F_i(t) \\ y_i(t) = Cx_i(t) + D^{w_i y_i} w_i(t) \end{cases} \quad (10)$$

where $x_i(t) = (e_i(t) \ v_i(t))^T$, $w_i(t) = v_{i-1}(t)$ and $y_i(t) = (v_{i-1}(t) \ e_i(t) \ v_i(t))^T$. The parameter h is varying within the range $[\underline{h}, \bar{h}]$. The matrices $A, B^{w_i}, B^{F_i}(h), C$ and $D^{w_i y_i}$ are given by

$$A = \begin{pmatrix} 0 & -1 \\ 0 & 0 \end{pmatrix}, B^{w_i} = \begin{pmatrix} 1 \\ 0 \end{pmatrix}, B^{F_i}(h) = \frac{1}{M_i} \begin{pmatrix} -h \\ 1 \end{pmatrix}, \quad (11)$$

$$C = \begin{pmatrix} 0 & 1 & 0 \\ 0 & 0 & 1 \end{pmatrix}^T, \quad D^{w_i y_i} = (1 \ 0 \ 0)^T.$$

³ For vehicle \mathcal{V}_1 , the velocity $v_0(t)$ is assumed available and transmitted by the platoon operator to vehicle \mathcal{V}_1 .

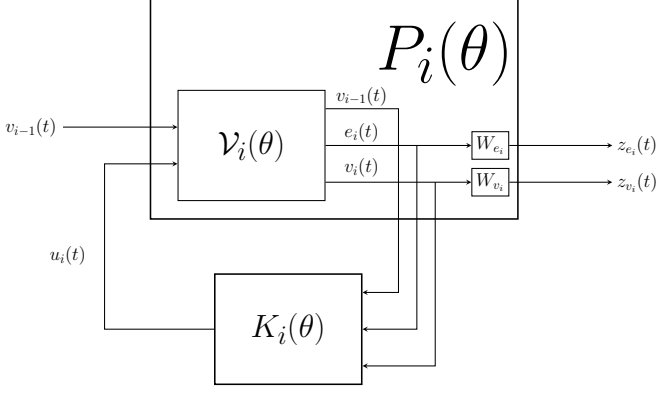

Fig. 2. The Generalized plant and the control synthesis scheme for vehicle \mathcal{V}_i .

Note that in the obtained state space representation (10) the resulting traction force $F_i(t)$ is the control input for the vehicle \mathcal{V}_i . Therefore, the control input matrix $B^{F_i}(h)$ is parameter dependent, which is not consistent with the H_∞ polytopic design approach. To solve this problem, a strictly proper filter $f_i(s)$ from a new control input $u_i(t)$ to the force $F_i(t)$ can be added into (10) in order to make the controlled input matrix $B^{F_i}(h)$ independent from the varying parameter h , that is

$$f_i(s) = \frac{\omega_{f_i}}{s + \omega_{f_i}}$$

where ω_{f_i} is the bandwidth which is chosen sufficiently large to decouple the input and the varying parameter h . This filter has the following state space representation

$$f_i : \begin{pmatrix} \dot{x}_{f_i}(t) \\ F_i(t) \end{pmatrix} = \begin{pmatrix} A_{f_i} & B_{f_i} \\ C_{f_i} & 0 \end{pmatrix} \begin{pmatrix} x_{f_i}(t) \\ u_i(t) \end{pmatrix} \quad (12)$$

where $x_{f_i}(t)$ is the state variable and

$$A_{f_i} = -\omega_{f_i} \quad B_{f_i} = -\omega_{f_i} \quad C_{f_i} = 1. \quad (13)$$

Using (10) and (12), a suitable LPV control oriented model for the vehicle \mathcal{V}_i is given by

$$\mathcal{V}_i(h) : \begin{cases} \dot{x}_{v_i}(t) = A_{v_i}(h)x_{v_i}(t) + B_{v_i}^{w_i}w_i(t) + B_{v_i}^{u_i}u_i(t) \\ y_i(t) = C_{v_i}x_{v_i}(t) + D_{v_i}^{w_i y_i}w_i(t) \end{cases} \quad (14)$$

where $x_{v_i}(t) = (x_i(t)^T \ x_{f_i}(t)^T)^T$ and the matrices A_{v_i} , $B_{v_i}^{w_i}$, $B_{v_i}^{u_i}$, C_{v_i} and $D_{v_i}^{w_i y_i}$ are given by

$$A_{v_i}(h) = \begin{pmatrix} A & B^{F_i}(h)C_{f_i} \\ 0 & A_{f_i} \end{pmatrix}, B_{v_i}^{w_i} = \begin{pmatrix} B^{w_i} \\ 0 \end{pmatrix} \quad (15)$$

$$B_{v_i}^{u_i} = \begin{pmatrix} 0 \\ B_{f_i} \end{pmatrix}, C_{v_i} = \begin{pmatrix} C \\ 0 \end{pmatrix}^T, D_{v_i}^{w_i y_i} = D^{w_i y_i}$$

with $h \in [\underline{h}, \bar{h}]$. The different matrices A , $B^{F_i}(h)$, B^{w_i} , C and $D^{w_i y_i}$ are given by (11) while A_{f_i} , B_{f_i} and C_{f_i} are given by (13).

3.3 Control scheme and vehicle \mathcal{V}_i augmented LPV model

The generalized parameter dependent plant $P_i(\theta)$ for the vehicle \mathcal{V}_i with the performance signals considered for the CACC design is given by Fig. 2.

In Fig. 2, the filters W_{e_i} and W_{v_i} are weighting functions added to account for performance specifications, which can be easily done for affine LPV systems.

- W_{e_i} is added to ensure the convergence of the inter-vehicle distance tracking errors towards zero. The requirement is guaranteed if for $\theta \in [\underline{h}, \bar{h}]$ the transfer function from $v_{i-1}(t)$ to $e_i(t)$ satisfies the frequency domain inequality, for all vertices θ_j , $j = 1, \dots, 2^{n_\theta}$, of the polytope

$$|T_{v_{i-1}(t) \rightarrow e_i(t)}(\mathbf{j}\omega, \theta_j)| \leq \frac{1}{|W_{e_i}(\mathbf{j}\omega)|}, \forall \omega \in \mathbf{R}^+, \forall \theta_j \quad (16)$$

with W_{e_i} of the form

$$W_{e_i}(s) = \frac{s/M_{e_i} + \omega_{e_i}}{s + \omega_{e_i}\epsilon}$$

where ω_{e_i} refers to the desired closed loop tracking error response cut-off frequency, ϵ refers to the the maximum permitted steady state error and M_{e_i} refers to the maximum permitted overshoot value for the error.

- W_{v_i} is added to ensure the platoon string stability requirement

$$\|v_i(t)\|_{\mathcal{L}_2} \leq \|v_{i-1}(t)\|_{\mathcal{L}_2}$$

which can be expressed as the frequency domain inequality for all vertices θ_j , $j = 1, \dots, 2^{n_\theta}$, of the polytope

$$|T_{v_{i-1}(t) \rightarrow v_i(t)}(\mathbf{j}\omega, \theta_j)| \leq \frac{1}{|W_{v_i}(\mathbf{j}\omega)|} \quad \forall \omega \in \mathbf{R}^+, \forall \theta_j \quad (17)$$

where

$$W_{v_i}(s) = 1.$$

The resulting LPV system $P_i(\theta)$ belongs to a polytope defined as the convex combination of systems defined at the two vertices $\theta = \underline{h}$ and $\theta = \bar{h}$. The controller $K_i(\theta)$ for this LPV system is easily found by applying the polytopic H_∞ approach presented above.

4. SIMULATION AND RESULTS

In this section, a validation of the designed CACC H_∞ LPV controller is performed. First, some frequency domain analysis are carried out to check that the closed loop of one vehicle with its designed controller meets the design requirements. Thereafter, some time domain simulations of five vehicle platoon are performed to check that the platoon control objectives are fulfilled.

Without loss of generality, the different parameters of the model, the weighting functions and the simulation settings are considered the same for all vehicles, as follows:

$$M_i = 1200 \text{ kg}, \quad \omega_{f_i} = 500 \text{ rad/s}, \quad \omega_{e_i} = 3 \text{ rad/s},$$

$$M_{e_i} = 1, \quad d_{0,i} = 5 \text{ m}, \quad L_{i-1,i} = 0 \text{ m},$$

$$\underline{h} = 0.5 \text{ s}, \quad \bar{h} = 2 \text{ s}.$$

4.1 Frequency domain analysis

The design requirements involve the inter-vehicle distance tracking error convergence and the string stability.

The convergence of inter-vehicle distance tracking errors towards zero is guaranteed if constraint (16) is respected.

Fig. 3 shows $|T_{v_{i-1}(t) \rightarrow e_i(t)}(\mathbf{j}\omega, \theta)|$ evaluated at the two vertices ($\theta = \underline{h}$ and $\theta = \bar{h}$) of the closed loop polytope and $1/|W_{e_i}(\mathbf{j}\omega)|$ is dashed red. As seen, the constraint (16) is respected as $|T_{v_{i-1}(t) \rightarrow e_i(t)}(\mathbf{j}\omega, \theta)|$ is always

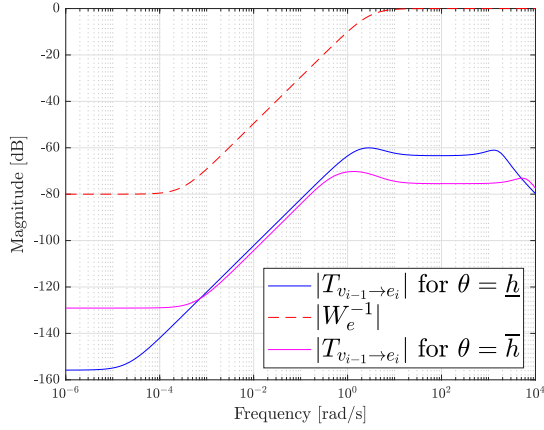

Fig. 3. Frequency domain investigation of the inter-vehicle distance tracking error convergence.

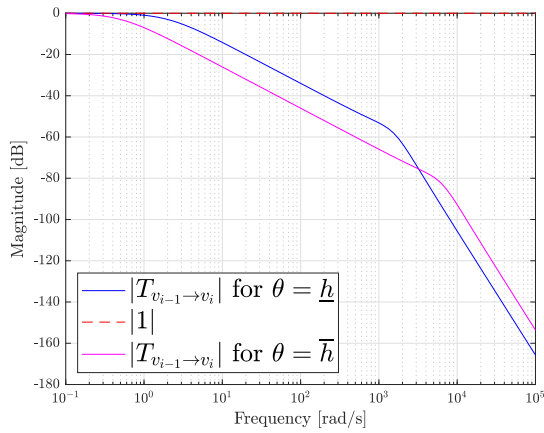

Fig. 4. Frequency domain investigation of string stability.

below $1/|W_{e_i}(\mathbf{j}\omega)|$. Therefore, the inter-vehicle distance tracking error convergence is achieved with the desired objectives (bandwidth, maximal overshoot and steady state).

The string stability is guaranteed if constraint (17) is respected. Fig. 4 shows $|T_{v_{i-1}(t) \to v_i(t)}(\mathbf{j}\omega, \theta)|$ evaluated at the two vertices ($\theta = \underline{h}$ and $\theta = \bar{h}$) of the closed loop polytope. As seen the constraint (17) is respected as $|T_{v_{i-1}(t) \to v_i(t)}(\mathbf{j}\omega, \theta)|$ is always less than 0 dB. Therefore, any input disturbance is attenuated along the platoon as it will be illustrated with the time domain analysis.

4.2 Time domain analysis

As the designed CACC H_∞ LPV controller satisfies the different control objectives, it can be implemented to simulate the behaviour of five vehicle platoon.

The performed simulation consists of two parts.

- Part A: Platoon creation starting a stationary state in order to illustrate the inter-vehicle distance tracking error convergence towards zero.
- Part B: Virtual leader velocity and time headway variations in order to illustrate the string stability even with parameter variations.

In Part A, the virtual leader velocity $v_0(t)$ changes from zero to reach a constant value while the time headway is constant with $h = 1$ s. The results are illustrated in Fig. 5.

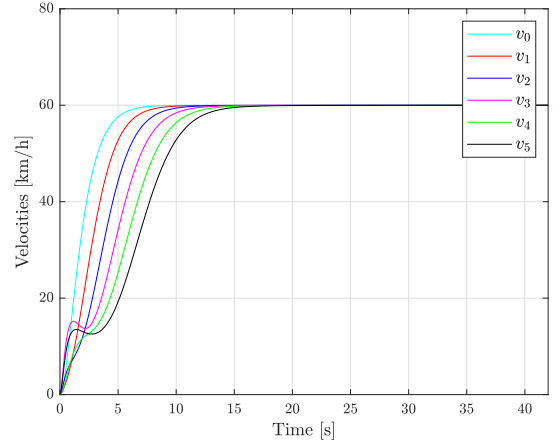

(a) Different vehicle velocities

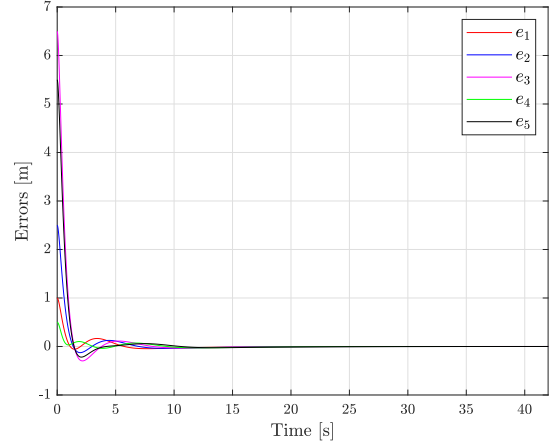

(b) Different inter-vehicle distance tracking errors

Fig. 5. Platoon creation illustration

Fig. 5-(a) illustrates how the different vehicle velocities convergence towards the virtual leader velocity (60 km/h). Meanwhile, the different inter-vehicle distance tracking errors converge towards zero as shown in Fig. 5-(b).

After all the different vehicle velocities has converged towards the virtual leader velocity and consequently all the inter-vehicle distance tracking errors have converged to zero, it is possible now to test the string stability of the vehicle platoon by introducing some variations in the virtual leader velocity.

In Part B, the virtual leader velocity $v_0(t)$ is increased or decreased according to a predefined scenario of accelerations and decelerations. In the same time, the time headway h is also increased or decreased (in accordance with $v_0(t)$) to test if the vehicle platoon remains string stable even when changing time headway h . The results are illustrated in Fig. 6.

Fig. 6-(a) illustrates how the virtual leader velocity $v_0(t)$ increases from 60 km/h to 120 km/h then decreases to achieve 20 km/h. Fig. 6-(c) shows how the time headway h is changed in accordance with the virtual leader velocity $v_0(t)$. As in Part A, the different vehicle velocities convergence towards the new virtual leader velocity values.

5. CONCLUSION

The problem of CACC with variable time headway was considered in this paper. The control objectives consists of ensuring that even with a variable time headway, the inter-vehicle distance tracking errors converge towards zero and that any disturbances on these errors are attenuated along the platoon. The problem is formulated within the LPV framework where a suitable oriented model is first obtained and the different control objectives are taken into account within the H_∞ control framework. Thereafter, a controller was obtained using the polytopic H_∞ approach. Frequency domain analysis are carried out to confirm that the obtained controller satisfy the different control objectives. Furthermore, time domain simulations are performed to illustrate that the inter-vehicle distance tracking error convergence and the platoon string stability are satisfied using the obtained controller.

REFERENCES

- Apkarian, P., Gahinet, P., and Becker, G. (1995). Self-scheduled h_∞ control of linear parameter-varying systems: a design example. *Automatica*, 31(9), 1251 – 1261.
- Flores, C., Milanés, V., and Nashashibi, F. (2017). A time gap-based spacing policy for full-range car-following. In *2017 IEEE 20th International Conference on Intelligent Transportation Systems (ITSC)*, 1–6.
- Hedrick, J.K., Tomizuka, M., and Varaiya, P. (1994). Control issues in automated highway systems. *IEEE Control Syst. Mag.*, 14(6), 21–32.
- Ioannou, P.A. and Chien, C.C. (1993). Autonomous intelligent cruise control. *IEEE Trans. Veh. Technol.*, 42(4), 657–672.
- Kayacan, E. (2017). Multiobjective h_∞ control for string stability of cooperative adaptive cruise control systems. *IEEE Trans. on Intell. Vehicl.*, 2(1), 52–61.
- Ploeg, J., Shukla, D.P., van de Wouw, N., and Nijmeijer, H. (2014). Controller synthesis for string stability of vehicle platoons. *IEEE Trans. Intell. Transp. Sys.*, 15(2), 854–865.
- Poussot-Vassal, C. (2009). *Robust LPV multivariable Automotive Global Chassis Control*. Ph.D. thesis, Institut National Polytechnique de Grenoble, France.
- Rajamani, R. and Zhu, C. (2002). Semiautonomous adaptive cruise control systems. *IEEE Trans. Veh. Technol.*, 51(5), 1186–1192.
- Seiler, P., Pant, A., and Hedrick, K. (2004). Disturbance propagation in vehicle strings. *IEEE Transc. Aut. Control.*, 49(10), 4268–4279.
- Shladover, S.E. (2005). Automated vehicles for highway operations (automated highway systems). *Proc. Inst. Mech. Eng. I: J. Syst. Control Eng.*, 219(1), 53–75.
- Swaroop, D. and Hedrick, J.K. (1996). String stability of interconnected systems. *IEEE Trans. Autom. Control*, 41(3), 349–357.
- Vahidi, A. and Eskandarian, A. (2003). Research advances in intelligent collision avoidance and adaptive cruise control. *IEEE Trans. Intell. Transp. Syst.*, 4(3), 143–153.
- Yanakiiev, D. and Kanellakopoulos, I. (1998). Nonlinear spacing policies for automated heavy-duty vehicles. *IEEE Transactions on Vehicular Technology*, 47(4), 1365–1377.

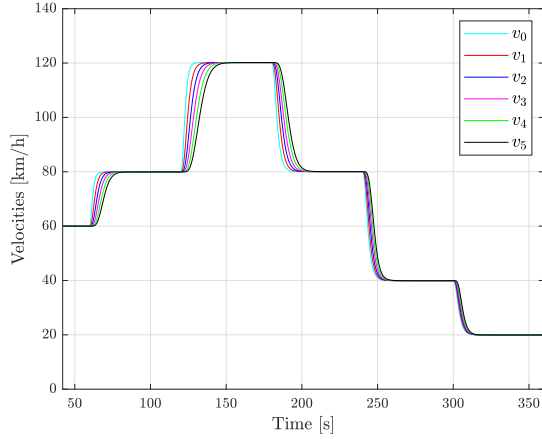

(a) Different vehicle velocities

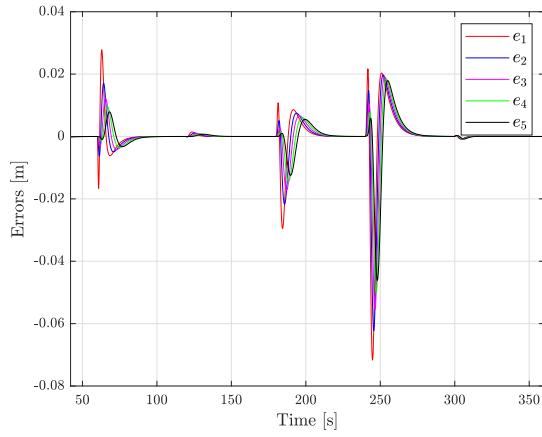

(b) Different inter-vehicle distance tracking errors

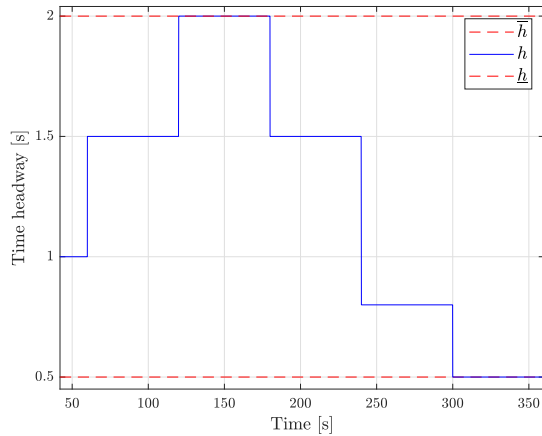

(c) Time headway variation

Fig. 6. String stability illustrations

The string stable behaviour of the vehicle platoon is illustrated Fig. 6-(b) where all the inter-vehicle distance tracking errors convergence towards zero with a decreasing disturbance propagation.

In conclusion, the frequency domain analysis and the time domain simulations performed in this section illustrate the efficiency of the designed CACC H_∞ LPV controller.